

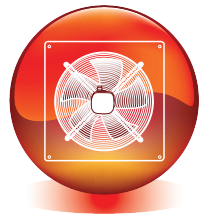

WALL MOUNTED



HPA Plate Mounted Axial Fans



Specification

Plates

Each HPA plate mounted fan includes a one piece bell mouth inlet and mounting plate manufactured in powder coated steel for rigidity with 4 fixing points for simple installation.

For added rigidity each unit includes a steel support frame to support the motor and impeller within the mounting plate.

Guards

Each HPA includes a finger protection guard to ISO13582 for mounting the fan onto the inlet ring.

Guards are electroplated prior to painting and finished in a tough epoxy polyester paint RAL 9005 Black.

Impellers

All impeller blades are pressed steel sickle bladed type with the exception of HPA 250mm and 300mm models which are conventional pressed steel blades, all providing excellent performance characteristics and low noise levels.

Impellers are epoxy painted colour RAL 9005 black and are welded to the motor rotor.

Motors

Motors are highly efficient, external rotor motors matched to the aerodynamic performance of the impeller. Motors have sealed for life, maintenance free ball bearings enabling the fan to be mounted at any angle.

Motors are protected to IP44 with Class F insulation and are suitable for ambient operating temperatures of up to +55° C and 95% maximum relative humidity and are wound for 230V/1Ph/50Hz or 400V/3Ph/50Hz supply.

All motors are pre-wired to an IP54 terminal box, incorporate built in thermal overload protection and are suitable for speed control.

Motors and impellers are balanced to Grade G6.3.

Dimensional Data

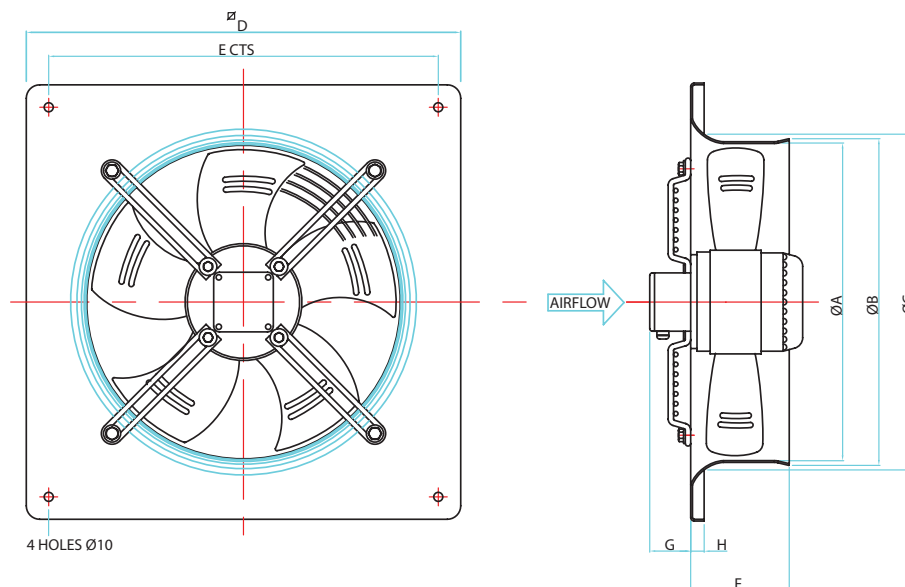

Product Code	A	B	C	D	E	F	G	H	Weight kg
HPA200/*.*A	200	210	215	312	260	52	60	15	2.5
HPA250/*.*A	250	260	265	370	320	90	60	15	3
HPA315/*.*A	315	325	360	430	380	90	60	15	3.3
HPA350/*.*A	350	360	395	485	435	90	60	15	4.9
HPA400/*.*A	400	410	450	540	490	110	60	15	7.2
HPA450/*.*A	450	460	500	575	535	110	60	15	7.2
HPA500/*.*A	500	510	560	655	615	115	60	15	9.5
HPA560/*.*A	560	575	625	725	670	115	60	15	10.5
HPA630/*.*A	630	645	705	805	750	125	60	20	15
HPA710/*.*A	710	725	765	850	810	130	135	27	25

Add 2, 4 or 6 for number of poles Add 1 or 3 for electrical phase

HPA Performance Curves & Performance Data

HPA200/2-1A, HPA250/2-1A, HPA315/2-1A

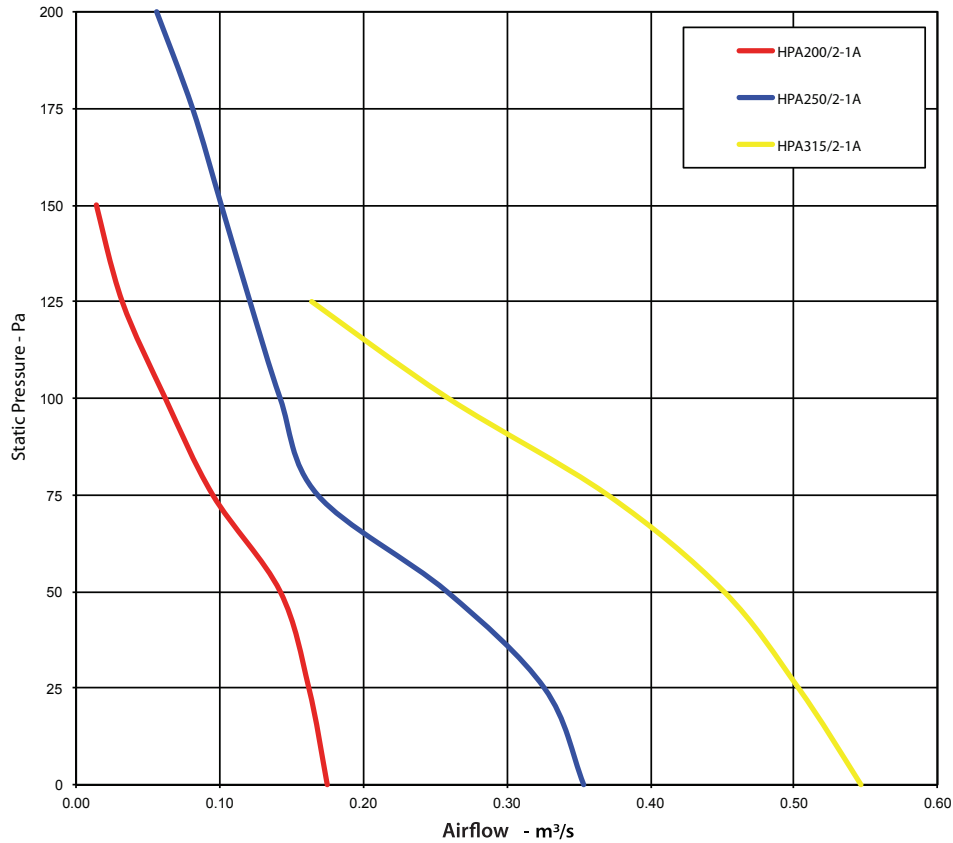

Product Code	Airflow, m ³ /s @ Static Pressure, Pa.								
	0	25	50	75	100	125	150	175	200
HPA200/2-1A	0.175	0.162	0.142	0.095	0.062	0.032	0.014	-	-
W/(L/s)	0.312	0.339	0.389	0.602	0.946	1.880	4.508	-	-
HPA250/2-1A	0.354	0.326	0.258	0.168	0.142	0.121	0.101	0.081	0.056
W/(L/s)	0.231	0.250	0.325	0.546	0.668	0.807	0.993	1.290	1.940
HPA315/2-1A	0.547	0.503	0.451	0.370	0.259	0.164	-	-	-
W/(L/s)	0.237	0.258	0.294	0.388	0.632	1.101	-	-	-

Product Code	Speed (rev/min)	220-240V/1Ph/50Hz			Sound Level dB(A) @ 3m	Weight kg
		Input Power Watts	FLC Amps	SC Amps		
HPA200/2-1A	2300	55	0.26	0.80	41	2.5
HPA250/2-1A	2400	80	0.40	1.20	51	3.0
HPA315/2-1A	2300	145	0.66	2.00	51	3.3

HPA Performance Curves & Performance Data

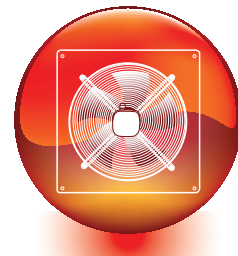

HPA250/4-1A, HPA315/4-1A, HPA350/4-1A

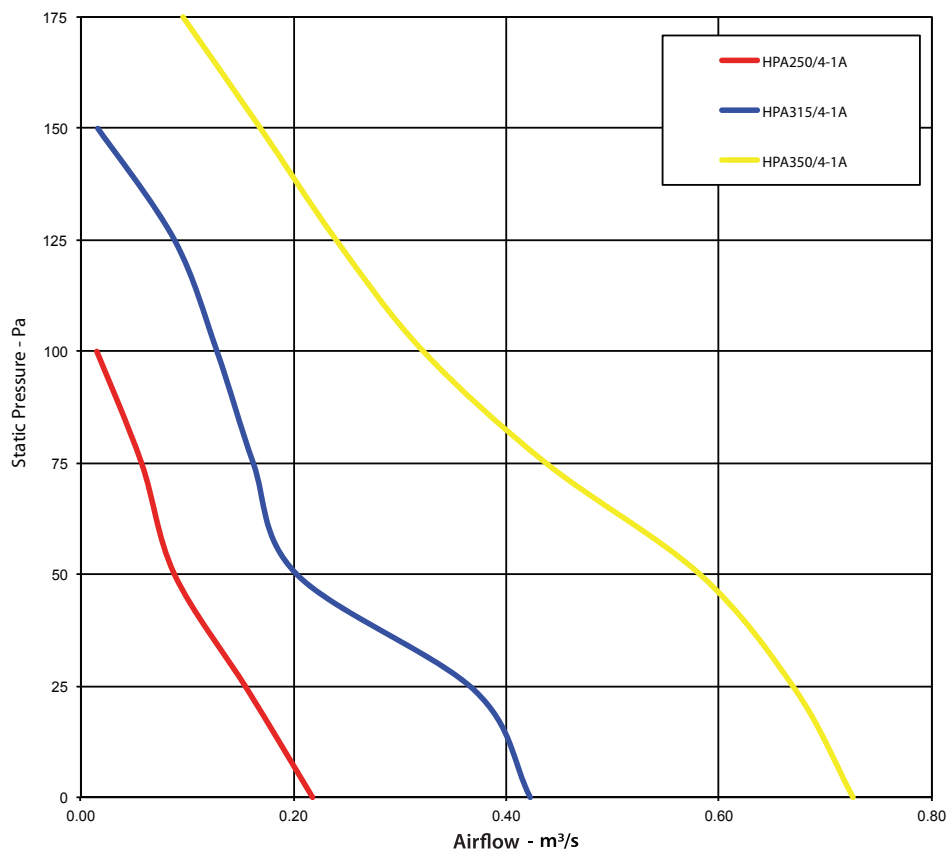

Product Code	Airflow, m ³ /s @ Static Pressure, Pa.							
	0	25	50	75	100	125	150	175
HPA250/4-1A	0.218	0.157	0.088	0.057	0.015	-	-	-
W/(L/s)	0.218	0.306	0.568	0.892	3.427	-	-	-
HPA315/4-1A	0.423	0.370	0.203	0.162	0.128	0.088	0.016	-
W/(L/s)	0.186	0.211	0.417	0.541	0.709	1.073	6.071	-
HPA350/4-1A	0.726	0.672	0.582	0.437	0.322	0.240	0.169	0.096
W/(L/s)	0.180	0.201	0.243	0.345	0.492	0.690	1.024	1.911

Product Code	Speed (rev/min)	Motor Electrical Data 220-240V/1Ph/50Hz			Sound Level dB(A) @ 3m	Weight kg
		Input Power Watts	FLC Amps	SC Amps		
HPA250/4-1A	1380	50	0.23	0.70	46	3.0
HPA315/4-1A	1350	75	0.35	1.10	49	3.3
HPA350/4-1A	1380	140	0.65	2.00	53	4.9

HPA Performance Curves & Performance Data

HPA400/4-1A, HPA450/4-1A, HPA500/4-1A, HPA560/4-1A

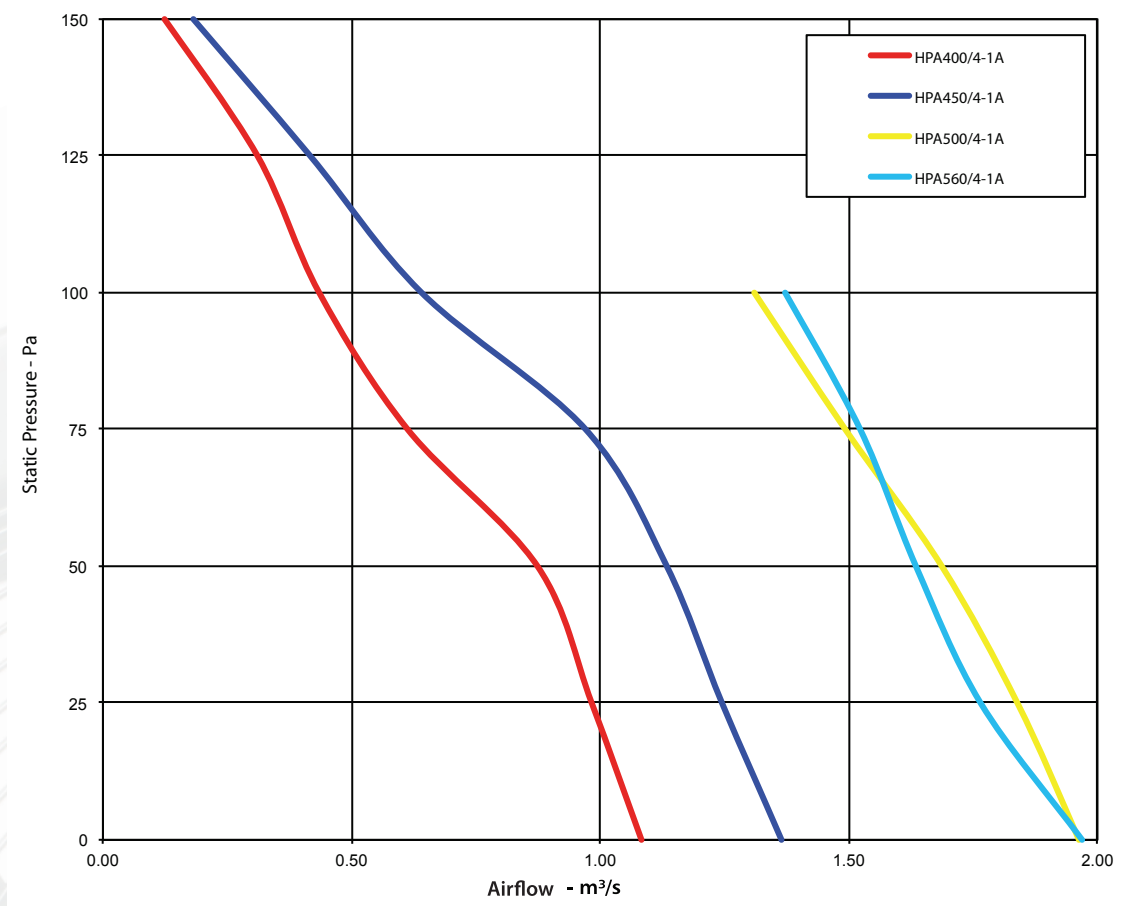

Product Code	Airflow, m³/s @ Static Pressure, Pa.						
	0	25	50	75	100	125	150
HPA400/4-1A	1.083	0.983	0.874	0.613	0.435	0.311	0.124
W/(L/s)	0.160	0.188	0.223	0.353	0.536	0.800	2.260
HPA450/4-1A	1.365	1.245	1.134	0.971	0.641	0.417	0.182
W/(L/s)	0.178	0.204	0.233	0.285	0.471	0.777	1.951
HPA500/4-1A	1.964	1.839	1.687	1.493	1.310	-	-
W/(L/s)	0.207	0.232	0.263	0.308	0.358	-	-
HPA560/4-1A	1.969	1.765	1.635	1.523	1.372	-	-
W/(L/s)	0.270	0.330	0.367	0.400	0.451	-	-

Product Code	Speed (rev/min)	Motor Electrical Data 220-240V/1Ph/50Hz			Sound Level dB(A) @ 3m	Weight kg
		Input Power Watts	FLC Amps	SC Amps		
HPA400/4-1A	1380	180	0.82	2.5	59	7.2
HPA450/4-1A	1350	250	1.20	3.6	59	7.2
HPA500/4-1A	1300	420	1.95	5.9	63	9.5
HPA560/4-1A	1300	550	2.55	7.7	66	10.5

Note: The HPA560/4-1A is not suitable for speed control applications.

HPA Performance Curves & Performance Data

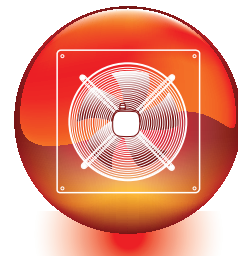

HPA400/6-1A. HPA450/6-1A. HPA500/6-1A. HPA560/6-1A. HPA630/6-1A

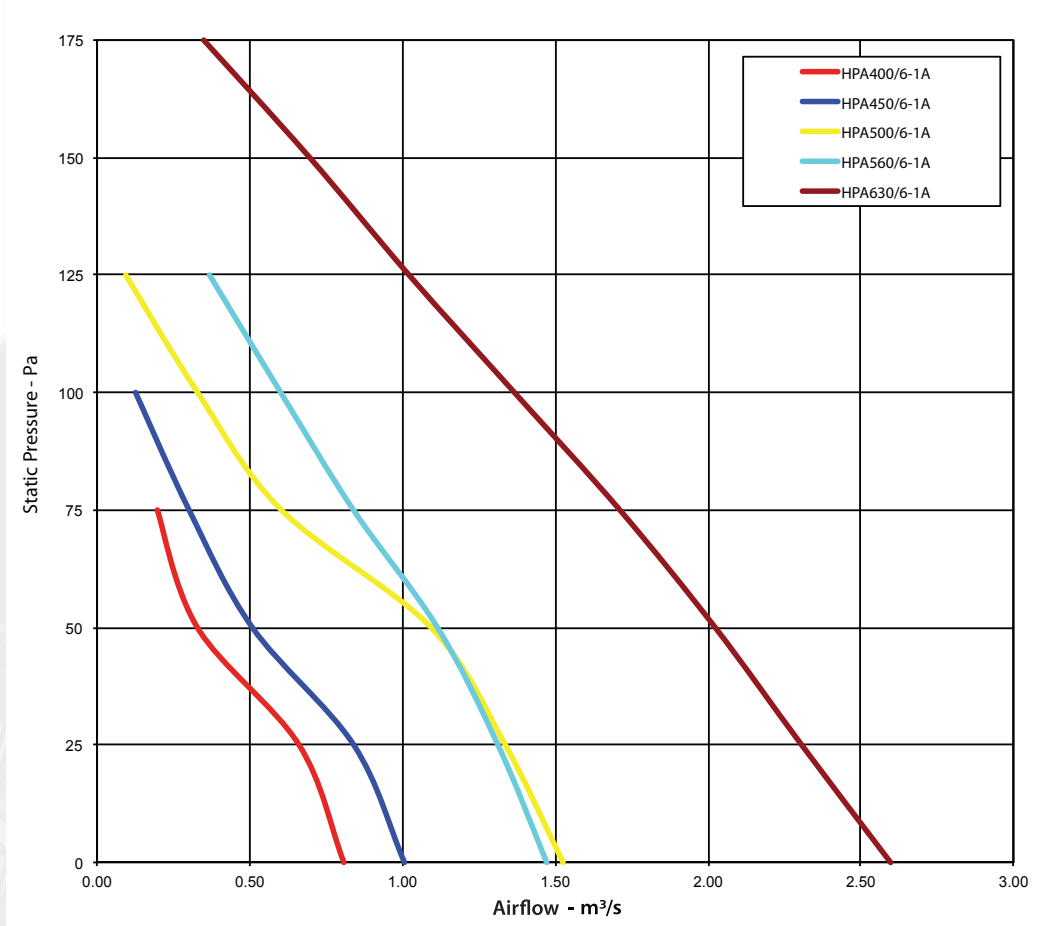

Product Code	Airflow, m ³ /s @ Static Pressure, Pa.							
	0	25	50	75	100	125	150	175
HPA400/6-1A	0.808	0.661	0.328	0.197	-	-	-	-
W/(L/s)	0.122	0.159	0.341	0.613	-	-	-	-
HPA450/6-1A	1.006	0.840	0.508	0.301	0.126	-	-	-
W/(L/s)	0.160	0.201	0.350	0.623	1.603	-	-	-
HPA500/6-1A	1.525	1.336	1.093	0.603	0.329	0.094	-	-
W/(L/s)	0.147	0.177	0.223	0.427	0.834	3.211	-	-
HPA560/6-1A	1.473	1.312	1.114	0.839	0.601	0.368	-	-
W/(L/s)	0.199	0.223	0.273	0.399	0.618	1.116	-	-
HPA630/6-1A	2.597	2.306	2.023	1.711	1.366	1.021	0.696	0.349
W/(L/s)	0.180	0.207	0.245	0.304	0.407	0.586	0.923	1.986

Product Code	Speed (rev/min)	Motor Electrical Data 220-240V/1Ph/50Hz			Sound Level dB(A) @ 3m	Weight kg
		Input Power Watts	FLC Amps	SC Amps		
HPA400/6-1A	920	110	0.50	1.50	49	7.2
HPA450/6-1A	920	150	0.70	2.10	51	7.2
HPA500/6-1A	900	230	1.15	3.50	59	9.5
HPA560/6-1A	900	330	1.70	5.10	61	10.5
HPA630/6-1A	900	520	2.50	7.50	66	15.0

HPA Performance Curves & Performance Data

HPA500/4-3A, HPA560/4-3A, HPA630/4-3A

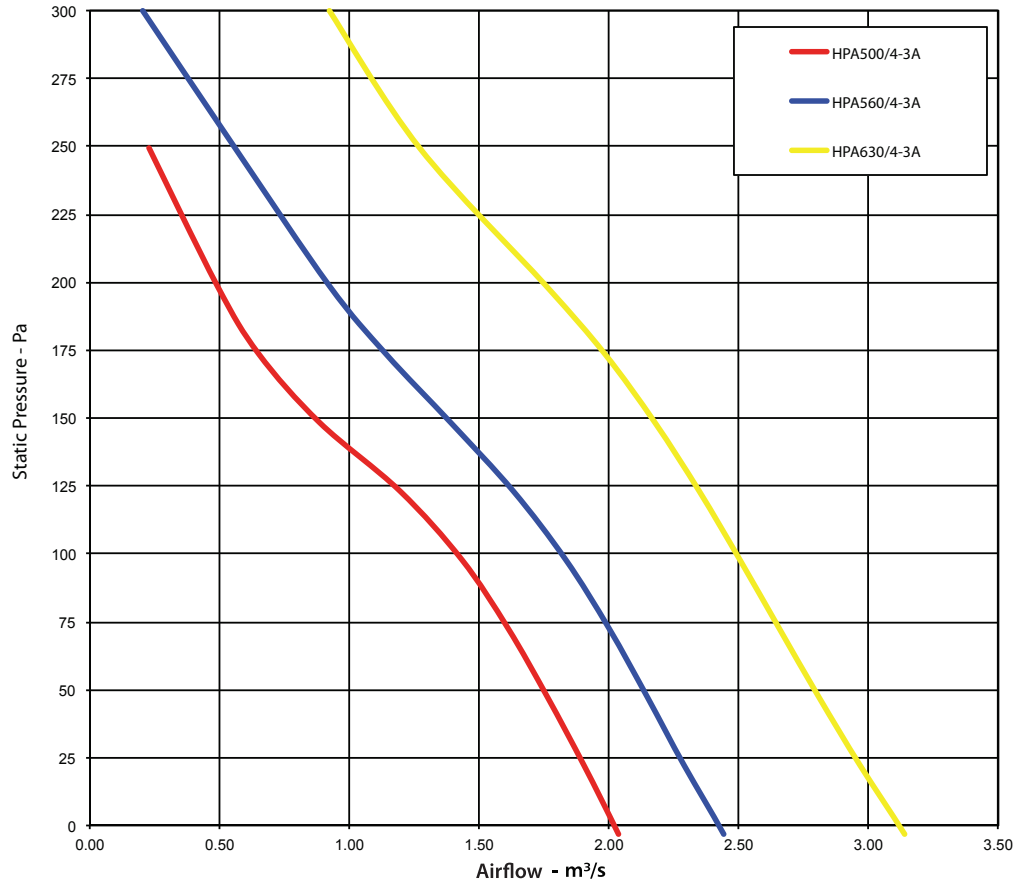

Product Code	Airflow, m³/s @ Static Pressure, Pa.										
	0	25	50	75	100	125	150	175	200	250	300
HPA500/4-3A	2.014	1.881	1.741	1.591	1.415	1.179	0.872	0.640	0.481	0.222	-
W/(L/s)	0.206	0.232	0.262	0.298	0.349	0.441	0.643	0.938	1.321	3.183	-
HPA560/4-3A	2.417	2.263	2.122	1.976	1.811	1.611	1.372	1.125	0.908	0.550	0.198
W/(L/s)	0.224	0.252	0.281	0.314	0.358	0.425	0.531	0.695	0.919	1.710	5.412
HPA630/4-3A	3.106	2.934	2.776	2.625	2.475	2.320	2.151	1.960	1.734	1.254	0.910
W/(L/s)	0.231	0.255	0.280	0.306	0.336	0.371	0.415	0.477	0.569	0.889	1.347

Product Code	Speed (rev/min)	Motor Electrical Data 380-415V/3Ph/50Hz			Sound Level dB(A) @ 3m	Weight kg
		Input Power Watts	FLC Amps	SC Amps		
HPA500/4-3A	1300	450	0.90	2.70	63	9.5
HPA560/4-3A	1300	600	1.20	3.60	75	10.5
HPA630/4-3A	1320	800	1.60	4.80	69	15.0

HPA Performance Curves & Performance Data

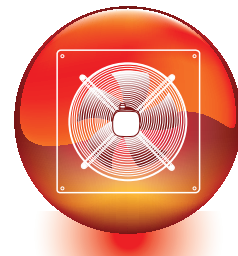

HPA500/6-3A, HPA560/6-3A, HPA630/6-3A, HPA710/6-3A

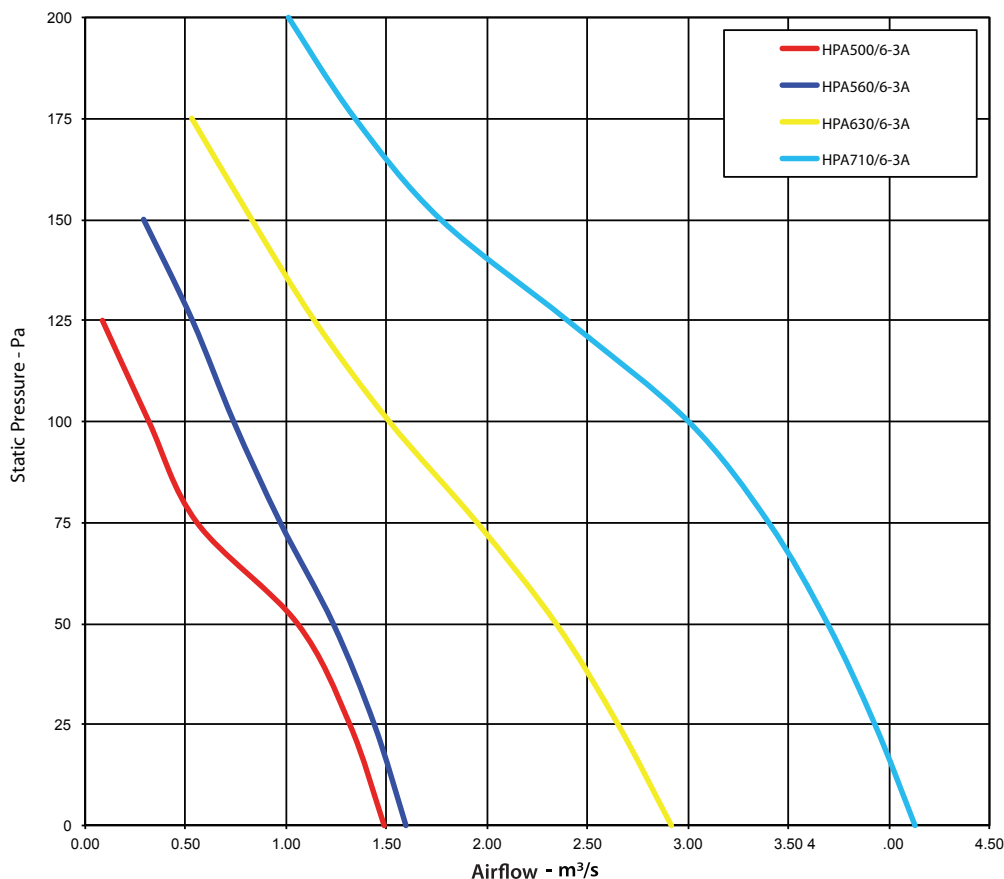

Product Code	Airflow, m ³ /s @ Static Pressure, Pa.								
	0	25	50	75	100	125	150	175	200
HPA500/6-3A	1.489	1.316	1.055	0.555	0.316	0.085	-	-	-
W/(L/s)	0.140	0.168	0.222	0.462	0.874	3.617	-	-	-
HPA560/6-3A	1.597	1.438	1.233	0.970	0.738	0.533	0.290	-	-
W/(L/s)	0.210	0.233	0.284	0.402	0.592	0.900	1.811	-	-
HPA630/6-3A	2.916	2.651	2.342	1.949	1.512	1.140	0.828	0.530	-
W/(L/s)	0.199	0.222	0.261	0.334	0.469	0.674	0.993	1.657	-
HPA710/6-3A	4.130	3.929	3.693	3.400	3.001	2.399	1.768	1.342	1.011
W/(L/s)	0.216	0.235	0.259	0.292	0.345	0.456	0.659	0.918	1.283

Product Code	Speed (rev/min)	Motor Electrical Data 380-415V/3Ph/50Hz			Sound Level dB(A) @ 3m	Weight kg
		Input Power Watts	FLC Amps	SC Amps		
HPA500/6-3A	900	230	0.55	1.7	59	9.5
HPA560/6-3A	900	330	0.90	2.7	61	10.5
HPA630/6-3A	900	550	1.60	4.8	66	15.0
HPA710/6-3A	900	900	1.90	5.7	71	25.0